



PHONE: (909) 993-5700
EMAIL: sales@deluxebuildingproducts.com
LOCATION: 1350 E. Lexington Ave., Pomona, CA 91766



www.DeluxeBuildingProducts.com

Deluxe Structural Tracks With 1-1/2" Legs

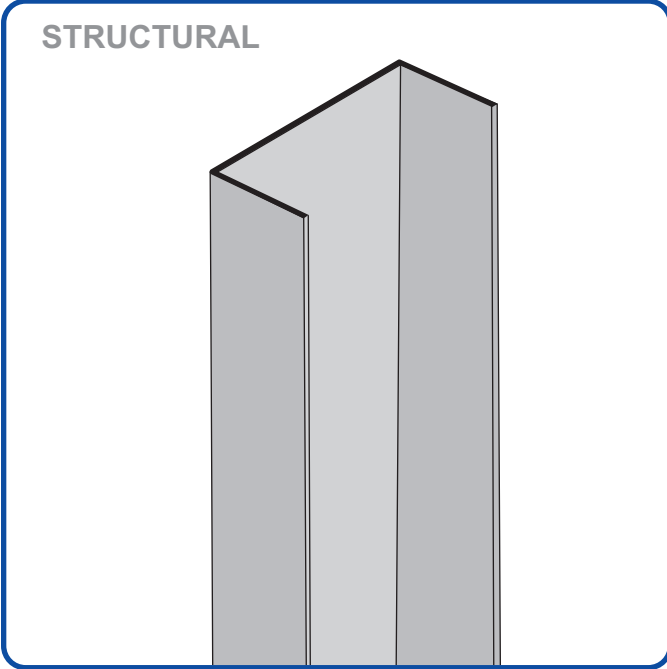

- ✓ Available in Galvanized Steel
- ✓ Available With Web in 162, 250, 362, 400, 600 and 800
- ✓ Custom Sizes Available!

The Deluxe Structural Tracks with 1-1/2" leg are lightweight, non-combustible and durable metal framing members, primarily used for interior walls and commercial construction. They offer superior stability compared to wood, offering no warping or rotting.

AVAILABLE DIMENSIONS

X Sizes: 1-5/8", 2-1/2", 3-5/8", 4", 6" or 8"

Available Materials:

Available in Galvanized Steel 20ga (30Mil), 18ga (43Mil), 16ga (54Mil) or 14ga (68Mil)

ASTM Codes:

All Accessories are fabricated from prime galvanized steel G60 (G90 upon request) zinc coating by the hot dipped method, conforming to steel and coating specification ASTM A-653/A-653M or zinc alloy meeting ASTM B-69. ASTM A 1003 OR A653 GRADE 33 OR 50 WITH G40, G60 OR G90

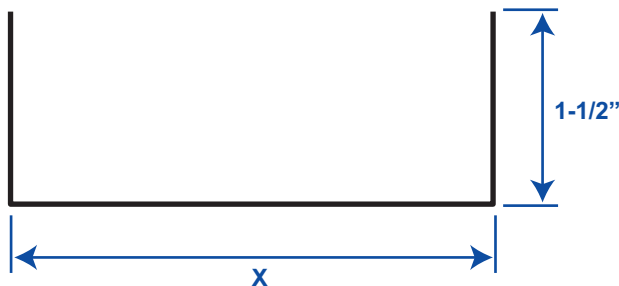

GET A QUOTE

Company: _____
 Name: _____
 Address: _____
 City: _____
 State: _____
 ZIP: _____
 Phone: _____
 Email: _____

Quantity: _____
 Material: _____
 X Size: _____
 Length: _____

Notes: _____





PHONE: (909) 993-5700
EMAIL: sales@deluxebuildingproducts.com
LOCATION: 1350 E. Lexington Ave., Pomona, CA 91766



www.DeluxeBuildingProducts.com

Deluxe Structural Tracks With 1-1/2" Legs

The Deluxe Structural Tracks with 1-1/2" leg are lightweight, non-combustible and durable metal framing members, primarily used for interior walls and commercial construction. They offer superior stability compared to wood, offering no warping or rotting.

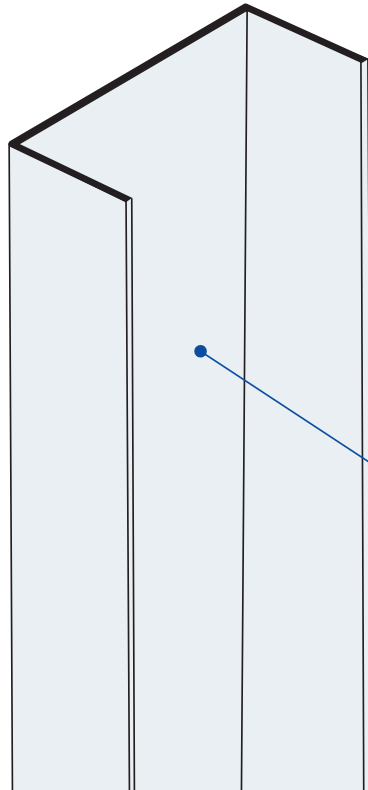

DELUXE
STRUCTURAL
STUDS - 1-1/2" LEG

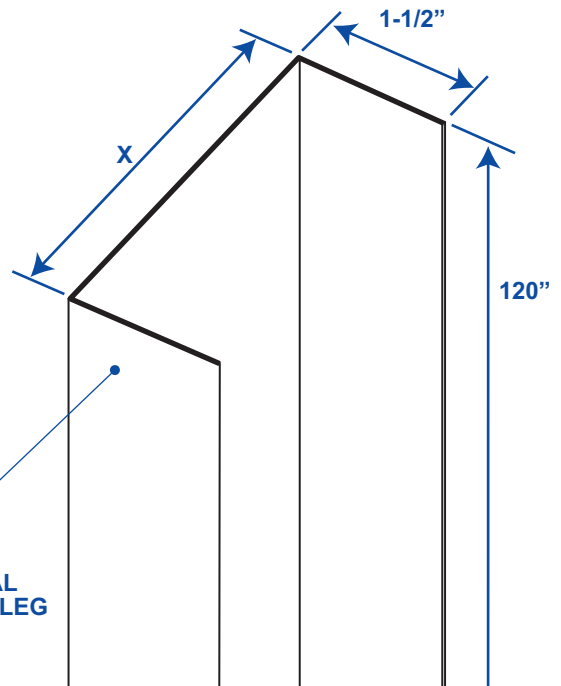
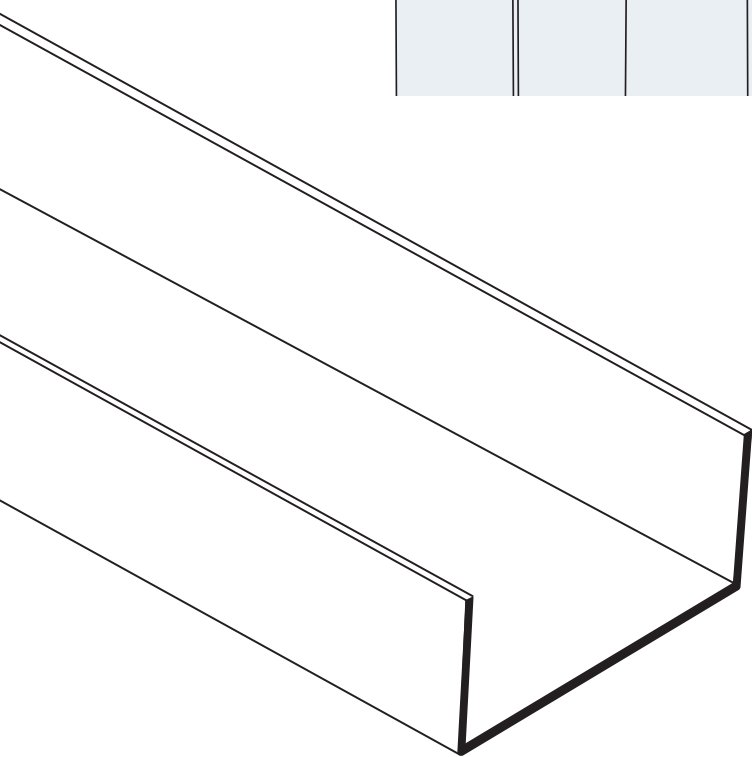

DELUXE
STRUCTURAL
STUDS - 1-1/2" LEG

NOTE: This drawing is supplied solely to assist in the selection and application of product manufactured by Deluxe Building Products. This drawing is generic in nature and should not be used in design or construction without an independent evaluation by a qualified Architect or Engineer of Record.

©2026 Deluxe Building Products. All rights reserved worldwide. Product illustrations are for reference only.
CA RESIDENTS: Please review Prop 65 by visiting www.P65Warnings.ca.gov

REV 04.01.26.DST2